

### Features

- Ultra low leakage: nA level
- Operating voltage: 3.3V
- Low clamping voltage
- Complies with following standards:
  - IEC 61000-4-2 (ESD) immunity test
    - Air discharge:  $\pm 30\text{kV}$
    - Contact discharge:  $\pm 30\text{kV}$
  - IEC61000-4-4 (EFT) 40A (5/50ns)
  - IEC61000-4-5 (Lightning) 10A (8/20  $\mu\text{s}$ )
- RoHS Compliant

### Applications

- USB Ports
- SIM Ports
- Smart Phones
- Wireless Systems
- Set-top box and digital TV
- Digital video interface (DVI)
- Ethernet 10/100/1000 Base T

### Dimensions DFN0603



### Pin Configuration

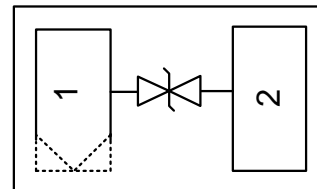

### Mechanical Characteristics

- Package: DFN0603
- Lead Finish: Lead Free
- UL Flammability Classification Rating 94V-0
- Quantity Per Reel: 10,000 pcs
- Reel Size: 7 inch
- Device Marking: 3Z



Caution:

This Device is designed for signal line protection only.

Not intended to be used under bias, not for application with a power line.

### Absolute Maximum Ratings (T<sub>amb</sub>=25°C unless otherwise specified)

Parameter	Symbol	Value	Unit
Peak Pulse Power (8/20 $\mu\text{s}$ )	P <sub>pp</sub>	50	W
ESD per IEC 61000-4-2 (Air)	V <sub>ESD</sub>	$\pm 30$	kV
ESD per IEC 61000-4-2 (Contact)		$\pm 30$	
Operating Temperature Range	T <sub>J</sub>	-55 to +150	°C
Storage Temperature Range	T <sub>STJ</sub>	-55 to +150	°C

**Electrical Characteristics** (TA=25°C unless otherwise specified)

Parameter	Symbol	Test Condition	Min	Typ	Max	Unit
Reverse Working Voltage	VRWM				3.3	V
Punch-Through Voltage	VPT	IT = 2μA	3.5			V
Snap-Back Voltage	VSB	IT = 50mA	0.8			V
Reverse Leakage Current	IR	VRWM = 3.3V			0.2	μA
Clamping Voltage	VC	IPP = 1A (8 x 20μs pulse)		4		V
Clamping Voltage	VC	IPP = 10A (8 x 20μs pulse)		5		V
Junction Capacitance	CJ	VR = 0V, f = 1MHz		0.6		pF

## Typical Performance Characteristics (TA=25°C unless otherwise specified)

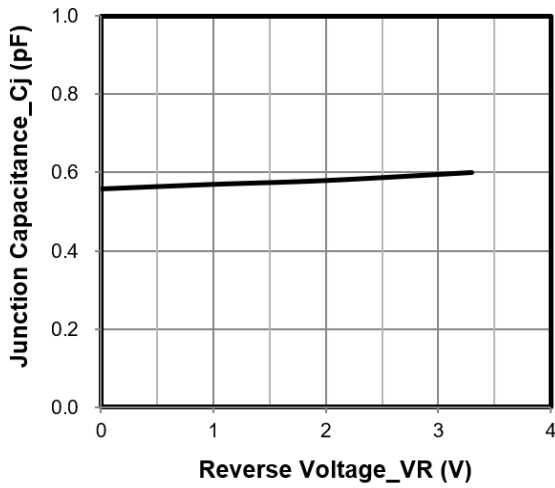

Junction Capacitance vs. Reverse Voltage

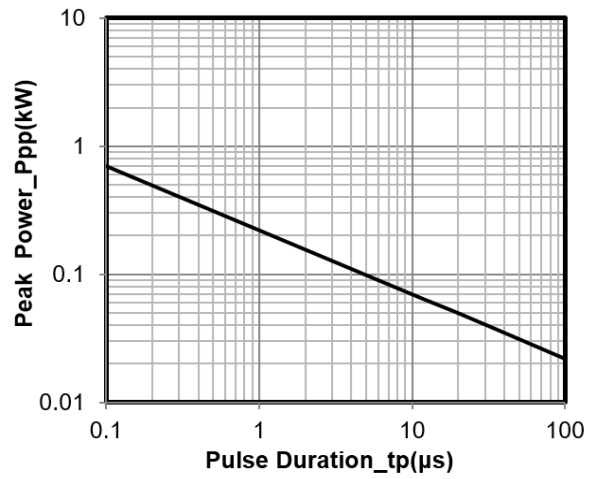

Peak Pulse Power vs. Pulse Time

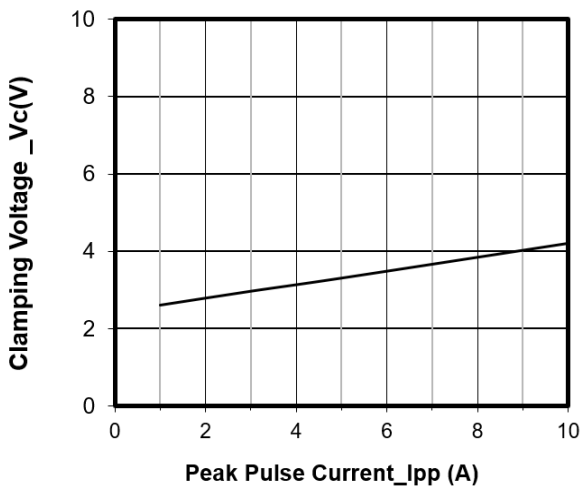

Clamping Voltage vs. Peak Pulse Current

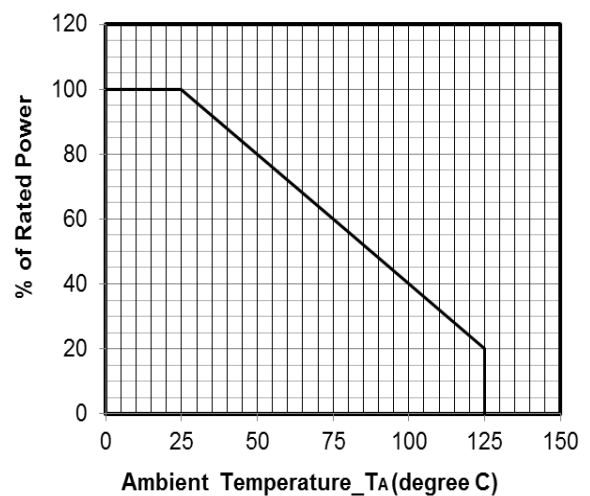

Power Derating Curve

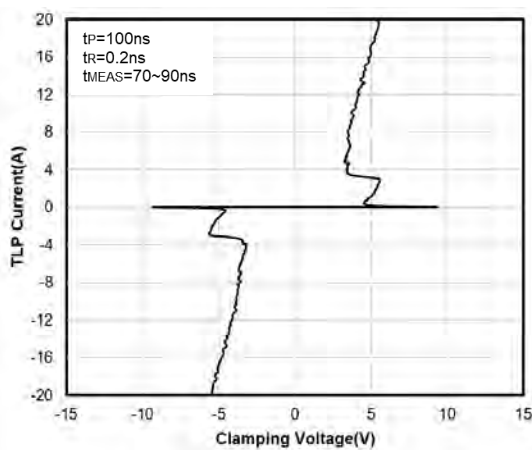

TLP Curve

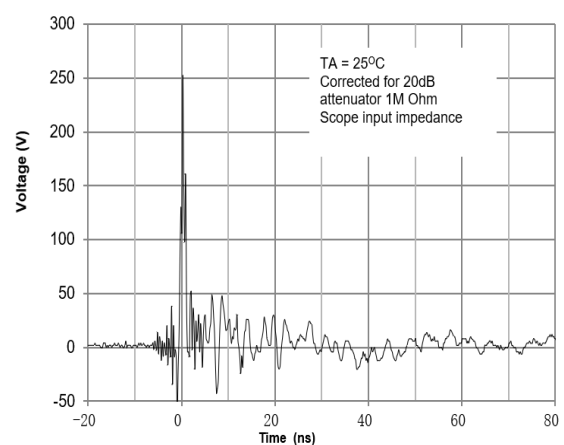

ESD Clamping Voltage  
8 kV Contact per IEC61000-4-2

## DFN0603 Package Outline Drawing

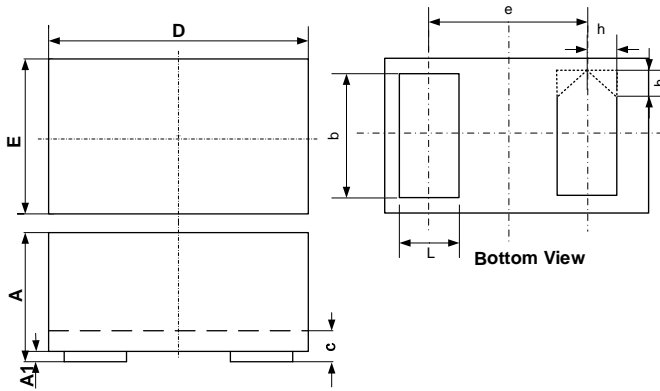

SYM	DIMENSIONS		
	MILLIMETERS		
	MIN	NOM	MAX
A	0.230		0.330
A1	0.000	0.020	0.050
b	0.215	0.245	0.275
c	0.120	0.150	0.180
D	0.550	0.600	0.650
e	0.355 BSC		
E	0.250	0.300	0.350
L	0.160	0.190	0.220
h	0.079 BSC		

## Suggested Land Pattern

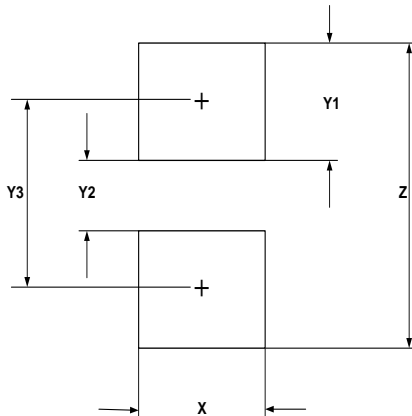

SYM	DIMENSIONS	
	MILLIMETERS	INCHES
X	0.30	0.012
Y1	0.25	0.010
Y2	0.15	0.006
Y3	0.40	0.016
Z	0.65	0.026

### NOTICE

Leiditech reserves the right to make modifications, enhancements, improvements, corrections or other changes without further notice to any product herein. Leiditech does not assume any liability arising out of the application or use of any product described herein.

Shanghai Leiditech Electronic Technology Co., Ltd.

Email: sale1@leiditech.com

Tel : +86- 021 50828806

Fax : +86- 021 50477059