

Features

- 56 Watts Peak Pulse Power per Line (tp=8/20 μ s)
- Protects High Speed I/O Lines & V_{BUS}
- Low Clamping Voltage
- RoHS Compliant
- IEC61000-4-2 (ESD) \pm 15kV (air), \pm 10kV (contact)
- IEC61000-4-4 (EFT) 40A (5/50ns)
- IEC61000-4-5 (LIGHTING) 3.5A (8/20 μ s)

Applications

- Digital Visual Interface
- USB Ports
- LCD TV
- Serial ATA
- Firewire Ports
- Customer Premise Equipment
- HDMI Ports
- Infiniband Transceiver Protection

Mechanical Characteristics

- DFN1510TP6Package
- Molding Compound Flammability Rating : UL 94V-O
- Weight 3.0 Milligrams (Approximate)
- Reel Size : 7 inch
- Lead Finish : Lead Free
- Device Marking : SL33

Dimensions DFN1510TP6

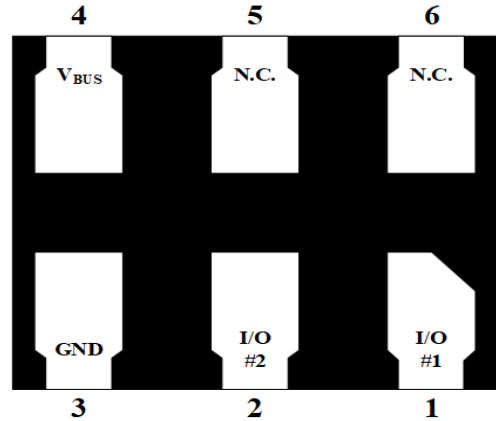

Pin Configuration

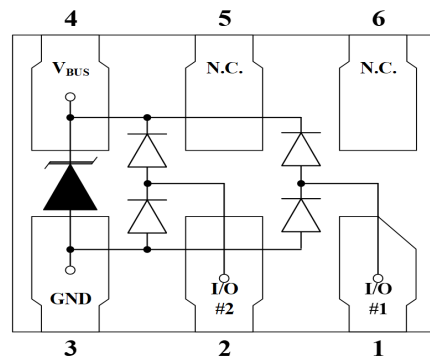

Absolute Maximum Ratings (T_{amb}=25°C unless otherwise specified)

PARAMETER	SYMBOL	VALUE	UNITS
Peak Pulse Power (tp=8/20 μ s waveform)	P _{PP}	56	Watts
Lead Soldering Temperature	T _L	260 (10 sec.)	°C
Operating Temperature Range	T _J	-40 ~ 125	°C
Storage Temperature Range	T _{STG}	-55 ~ 150	°C

Electrical Characteristics (TA=25°C unless otherwise specified)

Parameter	Symbol	Test Condition	Min	Typ	Max	Unit
Reverse Working Voltage	V_{RWM}				5.0	V
Breakdown Voltage	V_{BR}	$I_T = 1\text{mA}$	6			V
Reverse Leakage Current	I_R	$V_{RWM} = 3.3\text{V}$			0.1	μA
Clamping Voltage	V_C	$I_{PP} = 1\text{A}$ (8 x 20 μs pulse)			9.8	V
Clamping Voltage	V_C	$I_{PP} = 2\text{A}$ (8 x 20 μs pulse)			13	V
Clamping Voltage	V_C	$I_{PP} = 3.5\text{A}$ (8 x 20 μs pulse)			16	V
Transmission Line Pulse	TLP	$I_{OUT} = 1\text{A}$		8.5		V
Transmission Line Pulse	TLP	$I_{OUT} = 2\text{A}$		11		V
Transmission Line Pulse	TLP	$I_{OUT} = 5\text{A}$		14		V
Junction Capacitance	C_J	$V_R = 0\text{V}$, $f = 1\text{MHz}$ (I/O to I/O)		0.4		pF
Junction Capacitance	C_J	$V_R = 0\text{V}$, $f = 1\text{MHz}$ (I/O to GND)		0.8		pF

TYPIC CHARACTERISTICS

Figure 1. 8 x 20 μ s Waveform

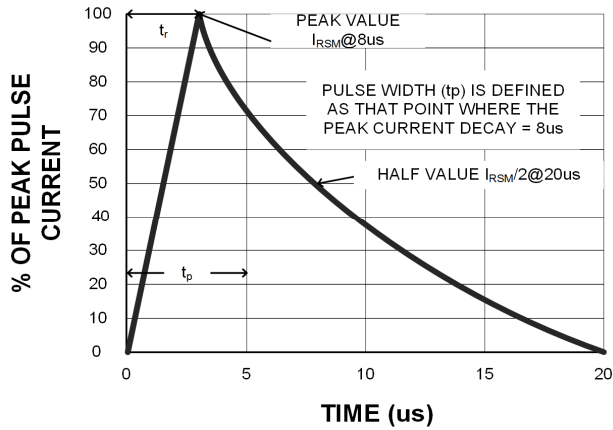

Figure 2. Power Derating Curve

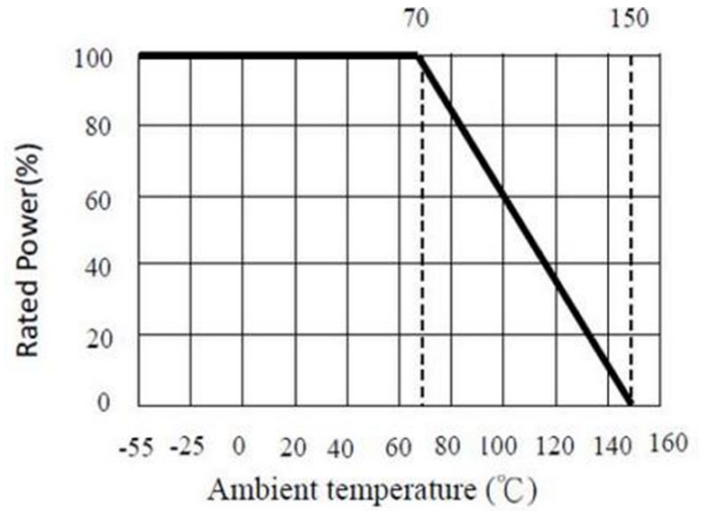

Figure 3. Clamping Voltage vs. Peak Pulse Current (TLP)

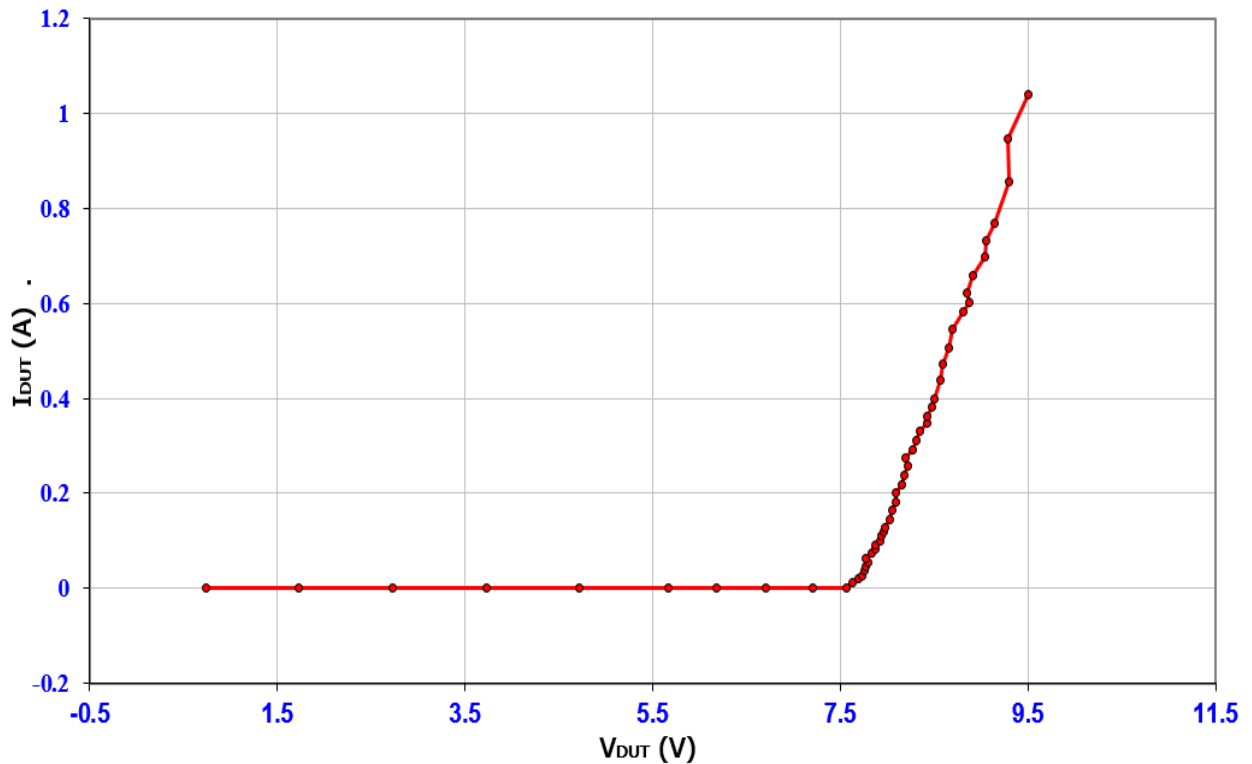

Figure 4. Typic Breakdown Voltage vs. Temperature

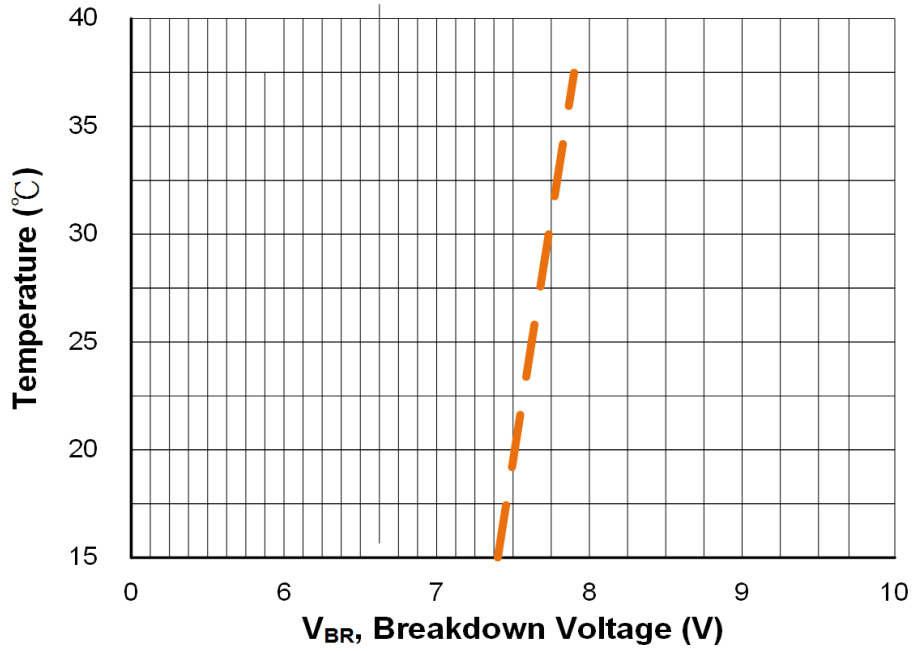

Figure 5. Typic Reverse Current vs. Temperature

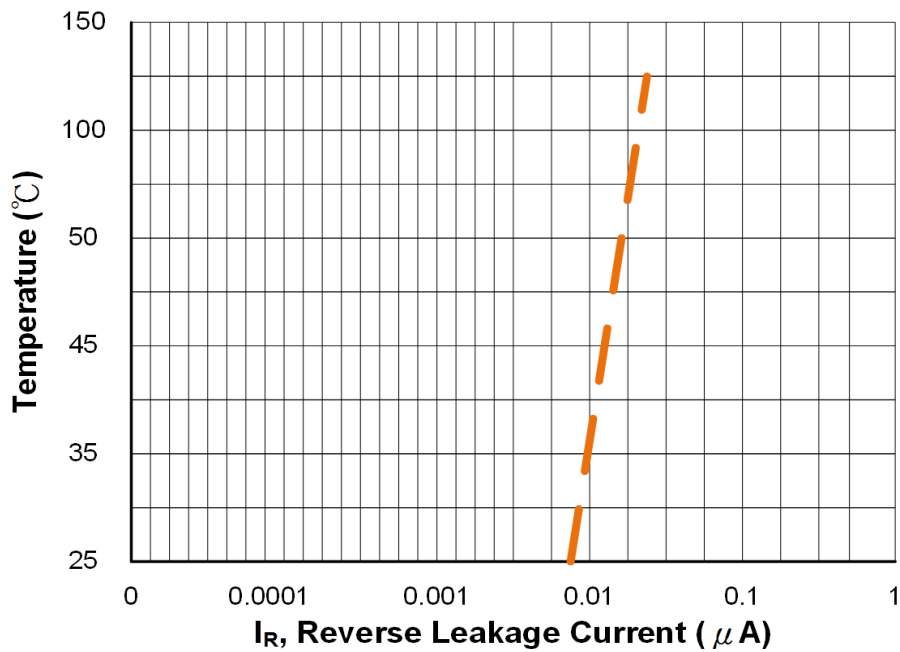

Figure 6. Typical Capacitance vs. Reverse Voltage

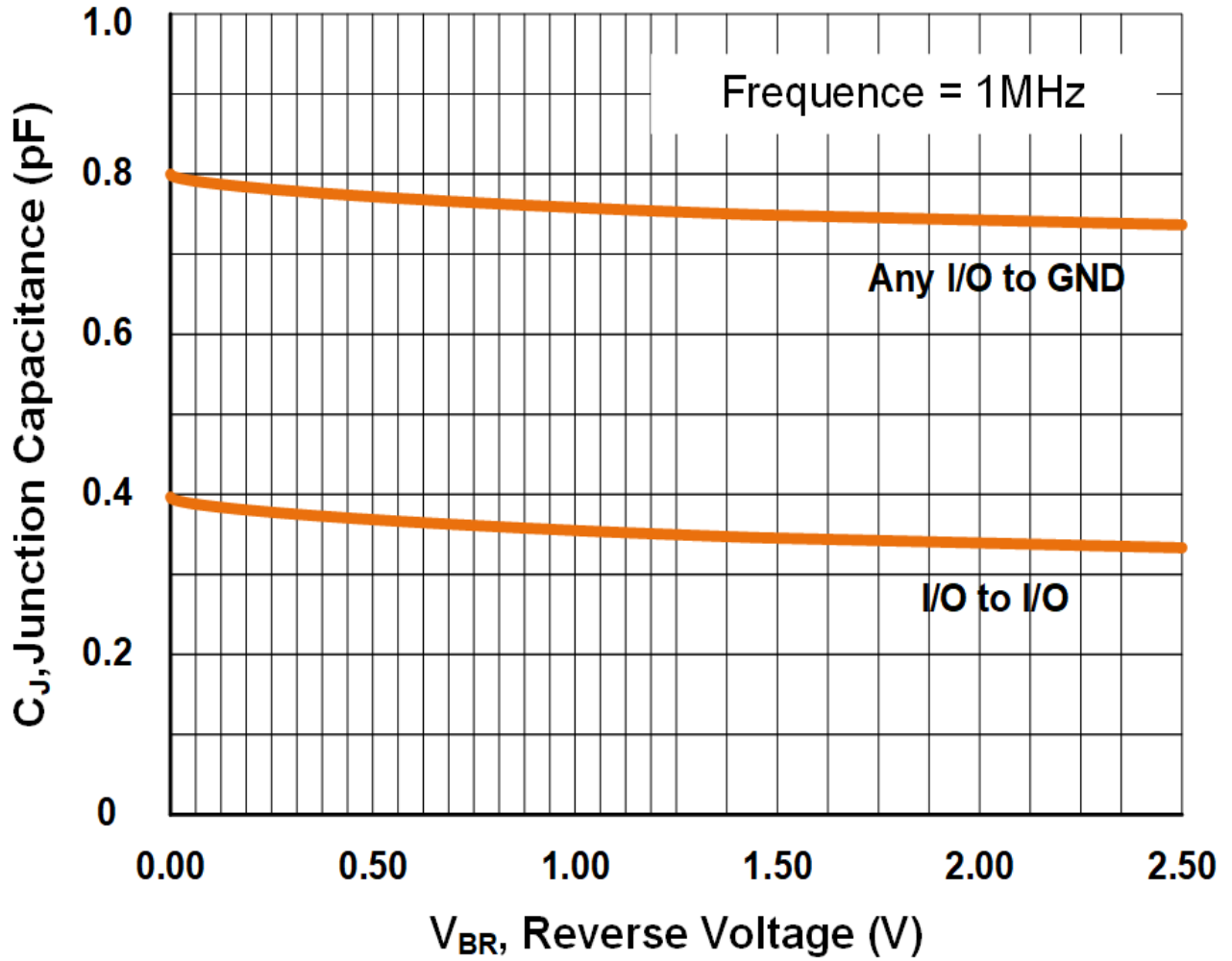
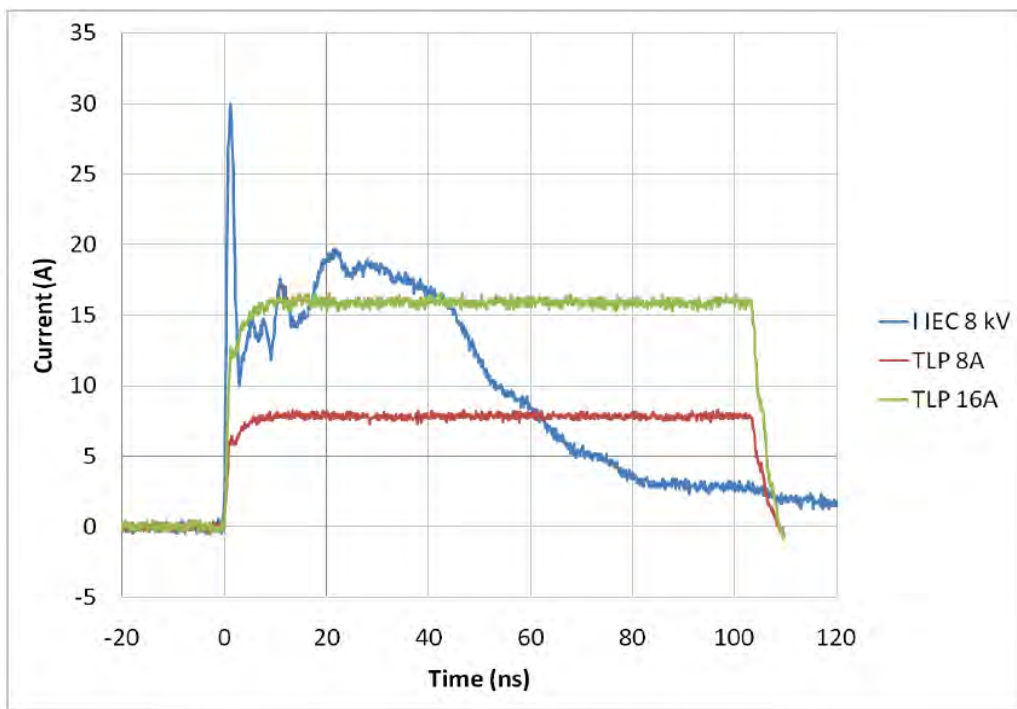

Figure 7. Transmission Line Pulse (TLP)

Transmission Line Pulse (TLP) is a measurement technique used in the Electrostatic Discharge (ESD) arena to characterize performance attributes of devices under ESD stresses. TLP is able to obtain current versus voltage (I-V) curves in which each data point is obtained with a 100 ns long pulse, with currents up to 40 A. TLP was first used in the ESD field to study human body model (HBM) in integrated circuits, but it is an equally valid tool in the field of system level ESD. The applicability of TLP to system level ESD is illustrated in Figure 1, which compares an 8 kV IEC 61000-4-2 current waveform with TLP current pulses of 8 and 16 A. The current levels and time duration for the pulses are similar and the initial rise time for the TLP pulse is comparable to the rise time of the IEC 61000-4-2's initial current spike. This application note will give a basic introduction to TLP measurements and explain the datasheet parameters extracted from TLP for SDI Technology's protection products.



Comparison Between 8 kV IEC 61000-4-2 and 8 A and 16 A TLP Waveforms

Comparison of a CurrentWaveform of IEC 61000-4-2with TLP Pulses at 8 and 16 A.

The IEC 61000-4-2 ESD waveforms is true to the Standard and is shown here as captured on an oscilloscope.

The points A, B, and C show the points on the aveforms specified in IEC 61000-4-2.

Transmission Line Pulse (TLP) Version.

Figure 8. Eye diagram on HDMI 1.4, USB 2.0 and

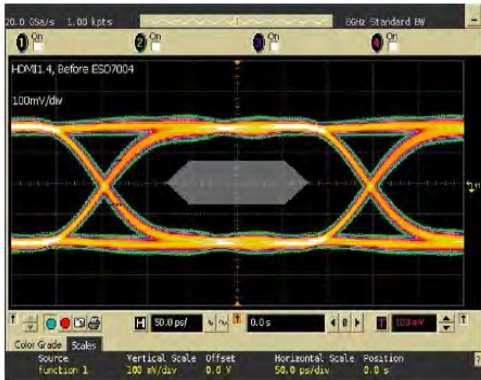

Fig. 8.1. @HDMI 1.4 mask at 3.4 Gbps per channel (Without Component)

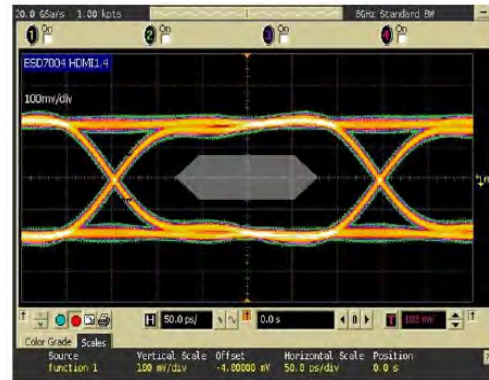

Fig. 8.2. @HDMI 1.4 mask at 3.4 Gbps per channel (With Component)

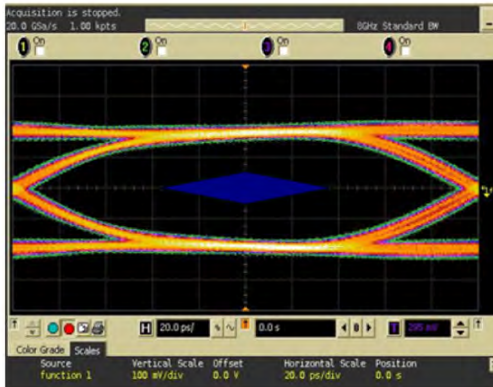

Fig. 8.3. @USB 2.0 mask at 3.2 Gbps per channel (Without Component)

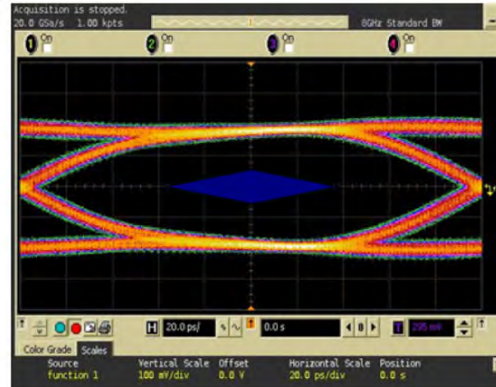

Fig. 8.4. @USB 2.0 mask at 3.2 Gbps per channel (With Component)

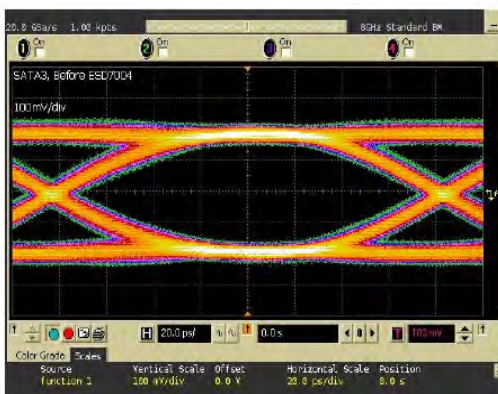

Fig. 8.5. @ESATA 2.0 mask at 3.8 Gbps per channel (Without Component)

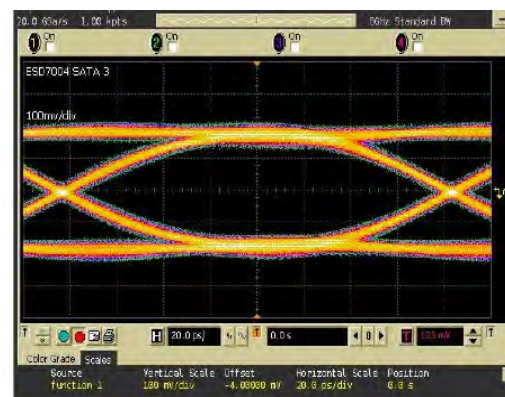
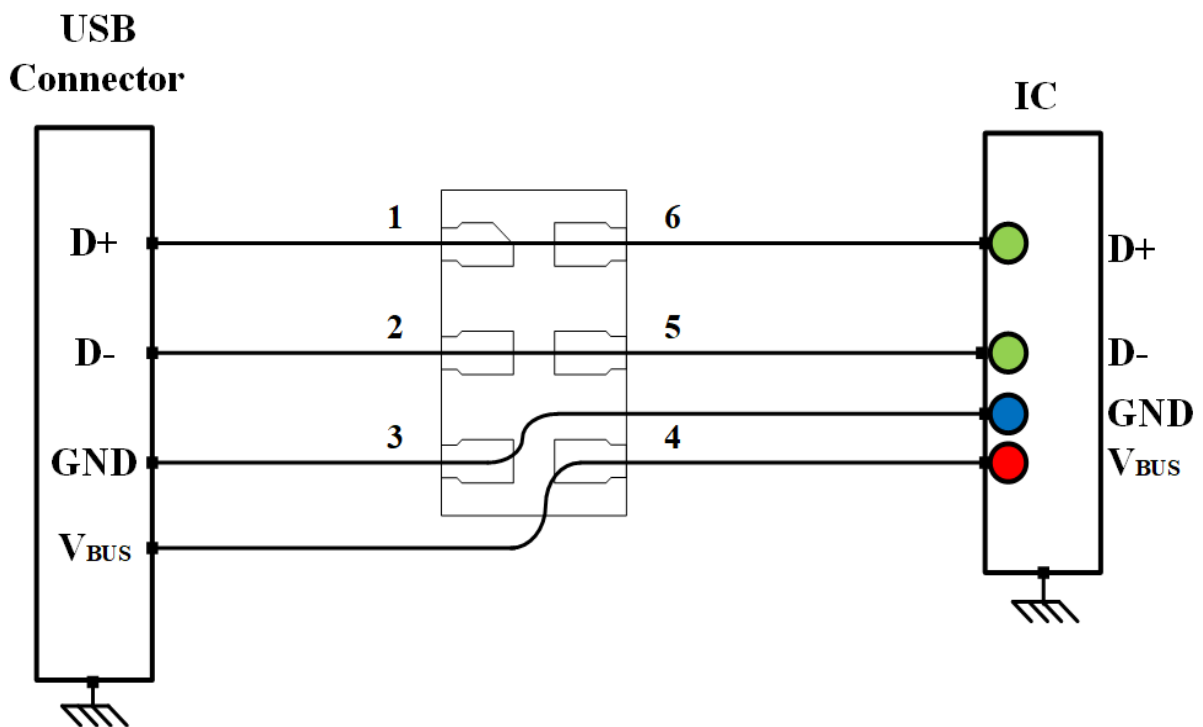

Fig. 8.6. @ESATA 2.0 mask at 3.8 Gbps per channel (With Component)

Figure 10. Layout Guidelines

Steps must be taken for proper placement and signal trace routing of the ESD protection device in order to ensure the maximum ESD survivability and signal integrity for the application. Such steps are listed below.

1. Place the ESD protection device as close as possible to the I/O connector to reduce the ESD path to ground and improve the protection performance.
 - 1.1. In USB 2.0 applications, the ESD protection device should be placed between the AC coupling capacitors and the I/O connector on the TX differential lanes as shown in below drawing In this configuration, no DC current can flow through the ESD protection device preventing any potential latch-up condition. For more information on latchup considerations, see below description on below drawing.
2. Make sure to use differential design methodology and impedance matching of all high speed signal traces.
 - 2.1. Use curved traces when possible to avoid unwanted reflections.
 - 2.2. Keep the trace lengths equal between the positive and negative lines of the differential data lanes to avoid common mode noise generation and impedance mismatch.
 - 2.3. Place grounds between high speed pairs and keep as much distance between pairs as possible to reduce crosstalk.



DFN1510TP6 PACKAGE OUTLINE & DIMENSIONS

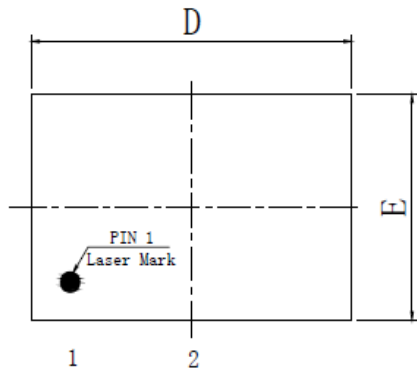

TOP VIEW

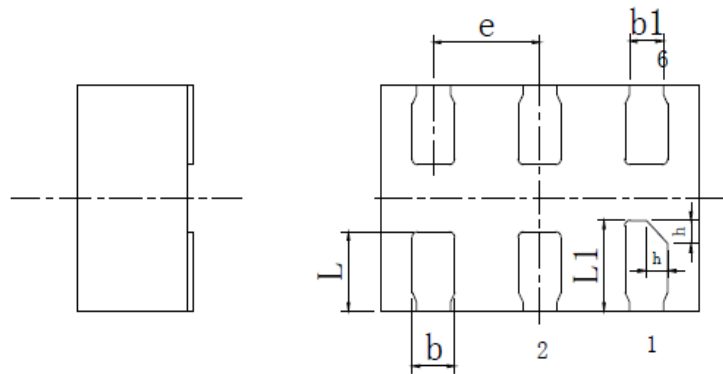

BOTTOM VIEW

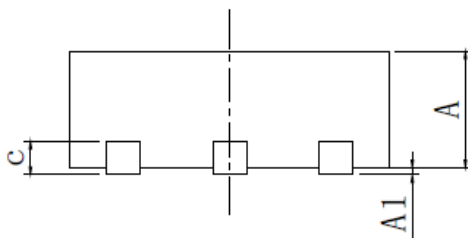

SIDE VIEW

SYMBOL	MILLIMETER		
	MIN	NOM	MAX
A	0.50	0.55	0.60
A1	0	0.02	0.05
b	0.15	0.20	0.25
b1	0.16REF		
c	0.15REF		
D	1.40	1.50	1.60
E	0.90	1.00	1.10
e	0.50BSC		
L	0.30	0.35	0.40
L1	0.35	0.40	0.45
h	0.05	0.10	0.15

NOTICE

Leiditech reserves the right to make modifications,enhancements,improvements,corrections or other changes without further notice to any product herein. Leiditech does not assume any liability arising out of the application or use of any product described herein.

Shanghai Leiditech Electronic Co.,Ltd
 Email: sale1@leiditech.com
 Tel : +86- 021 50828806
 Fax : +86- 021 50477059