

Features

- Ultra small package: 1.0x0.6x0.5mm
- Ultra low capacitance: 0.3pF typical (I/O-I/O)
- Ultra low leakage: nA level
- Low operating voltage: 5V
- Low clamping voltage
- 3-pin leadless package
- Up to 2-line protects
- Complies with following standards:
 - IEC 61000-4-2 (ESD) immunity test
Air discharge: $\pm 30\text{kV}$
Contact discharge: $\pm 25\text{kV}$
 - IEC61000-4-4 (EFT) 40A (5/50ns)
 - IEC61000-4-5 (Lightning) 5A (8/20 μs)
- RoHS Compliant

Dimensions DFN1006-3

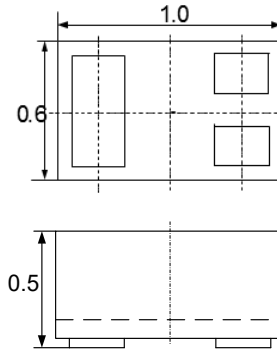

Pin Configuration

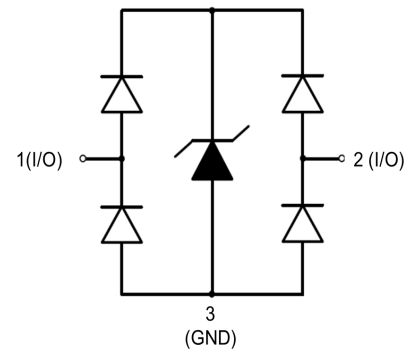

Applications

- Cellular Handsets and Accessories
- Display Ports
- MDDI Ports
- USB 2.0 and 3.0 Ports
- HDMI 1.3 and 1.4
- Digital Video Interface (DVI)
- PCI Express and Serial SATA Ports
- Notebook Computer
- IEEE 1394

Mechanical Characteristics

- Package: DFN1006-3 (1.0x0.6x0.5mm)
- Lead Finish: NiPdAu
- Case Material: "Green" Molding Compound.
- UL Flammability Classification Rating 94V-0
- Moisture Sensitivity: Level 3 per J-STD-020
- Terminal Connections: See Diagram Below
- Marking Information: See Below

Absolute Maximum Ratings (Tamb=25°C unless otherwise specified)

Parameter	Symbol	Value	Unit
Peak Pulse Power (8/20 μs)	P _{pp}	75	W
ESD per IEC 61000-4-2 (Air)	V _{ESD}	± 30	Kv
ESD per IEC 61000-4-2 (Contact)		± 25	
Operating Temperature Range	T _J	-55 to +150	°C
Storage Temperature Range	T _{STJ}	-55 to +150	°C

Electrical Characteristics(TA=25°C unless otherwise specified)

Part Number	Device Marking	V _{RWM} (V)	V _{BR} (V)	I _T (mA)	V _C @1A	V _C		I _R μA (Max)	C (Pf) (Typ.)
						(Max)	(@A)		
ULC0502P3	52	5	6	1	10	13	5	0.5	0.6

Typical Performance Characteristics (TA=25°C unless otherwise Specified)

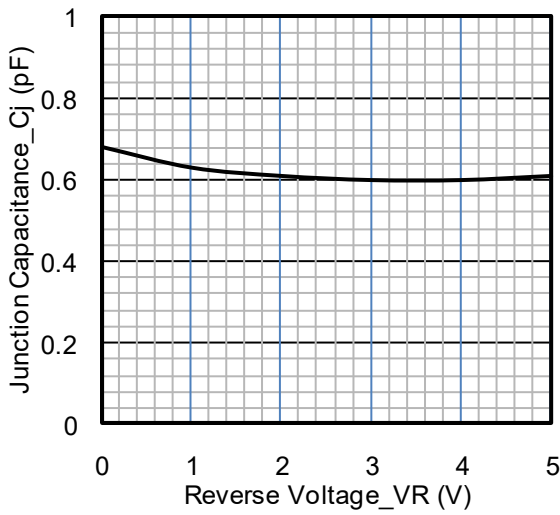

Junction Capacitance vs. Reverse Voltage

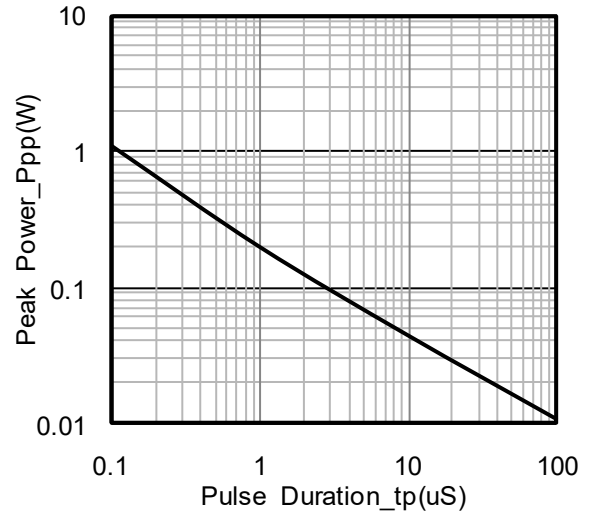

Peak Pulse Power vs. Pulse Time

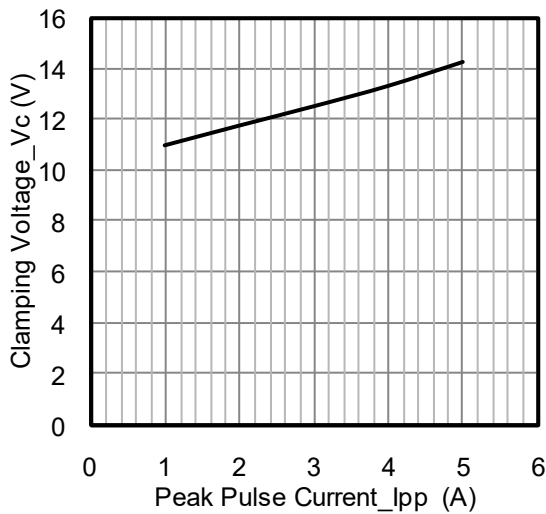

Clamping Voltage vs. Peak Pulse Current

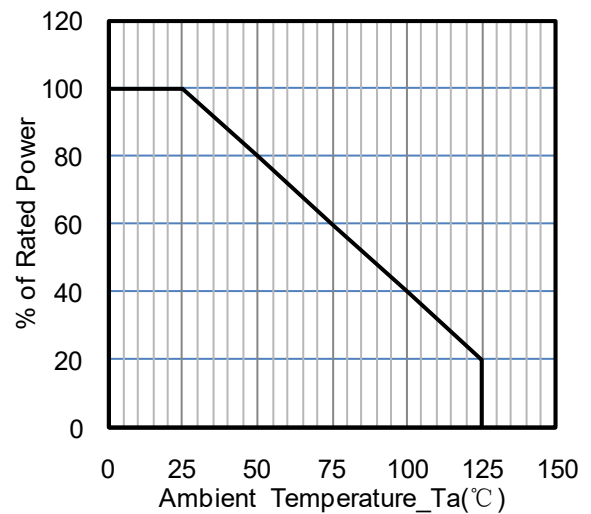

Power Derating Curve

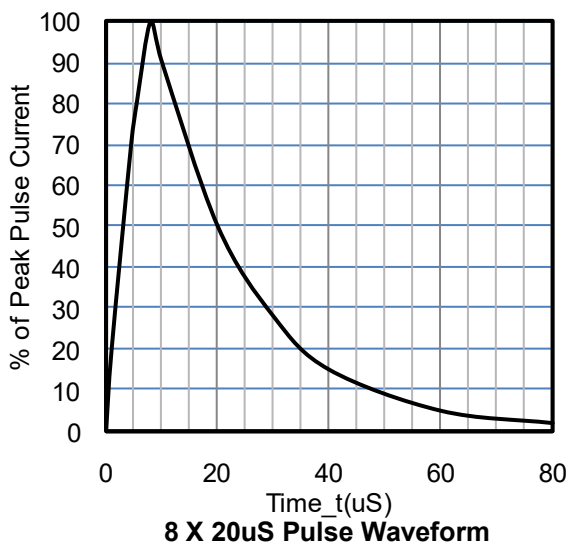

8 X 20uS Pulse Waveform

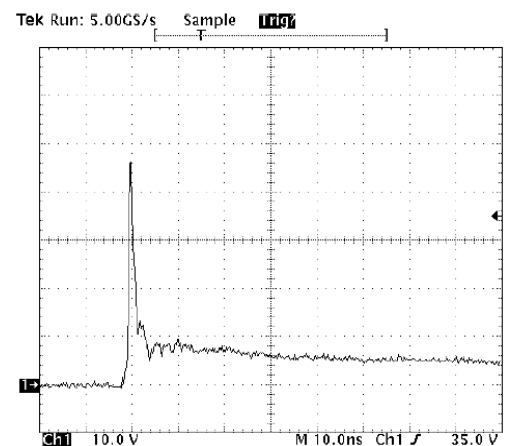

ESD Clamping Voltage

8 kV Contact per IEC61000-4-2

DFN1006-3 Package Outline Drawing

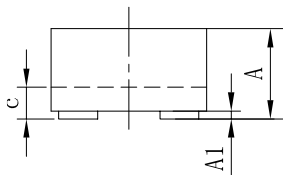
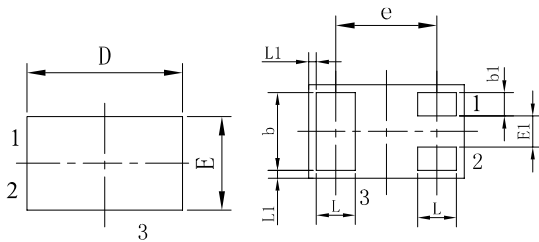

SYM	DIMENSIONS					
	MILLIMETERS			INCHES		
	MIN	NOM	MAX	MIN	NOM	MAX
A	0.45	0.50	0.55	0.018	0.020	0.022
A1	0.00	0.02	0.05	0.000	0.001	0.002
b	0.45	0.50	0.55	0.018	0.020	0.022
b1	0.10	0.15	0.20	0.004	0.006	0.008
c	0.12	0.15	0.18	0.005	0.006	0.007
D	0.95	1.00	1.05	0.037	0.039	0.041
e	0.65 BSC			0.026 BSC		
E	0.55	0.60	0.65	0.022	0.024	0.026
E1	0.15	0.20	0.25	0.006	0.008	0.010
L	0.20	0.25	0.30	0.008	0.010	0.012
L1	0.05 REF			0.0002 REF		

Suggested Land Pattern

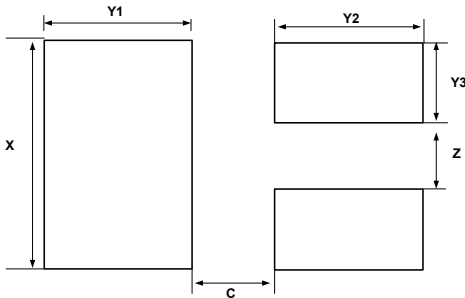

SYM	DIMENSIONS	
	MILLIMETERS	INCHES
C	0.25	0.010
X	0.65	0.024
Y1	0.50	0.020
Y2	0.50	0.020
Y3	0.25	0.010
Z	0.20	0.008