

Dimensions SOD-323

FEATURES

For use in low voltage, high frequency inverters
Free wheeling, and polarity protection applications.



MARKING: B5817WS: SJ
B5818WS:SK
B5819WS: SL

Maximum Ratings and Electrical Characteristics, Single Diode @T_A=25°C

Parameter	Symbol	B5817WS	B5818WS	B5819WS	Unit
Non-Repetitive Peak reverse voltage	V _{RM}	20	30	40	V
Peak repetitive Peak reverse voltage Working Peak Reverse Voltage DC Blocking Voltage	V _{RRM} V _{RWM} V _R	20	30	40	V
RMS Reverse Voltage	V _{R(RMS)}	14	21	28	V
Average Rectified Output Current	I _O	1			A
Peak forward surge current @=8.3ms	I _{FSM}	9			A
Repetitive Peak Forward Current	I _{FRM}	1.5			A
Power Dissipation	P _d	250			mW
Thermal Resistance Junction to Ambient	R _{θJA}	500			°C/W
Storage temperature	T _{STG}	-65~+150			°C

ELECTRICAL CHARACTERISTICS (T_{amb}=25°C unless otherwise specified)

Parameter	Symbol	Test conditions	MIN	MAX	UNIT
Reverse breakdown voltage	V _(BR)	I _R = 1mA B5817WS B5818WS B5819WS	20 30 40		V
Reverse voltage leakage current	I _R	V _R =20V B5817WS V _R =30V B5818WS V _R =40V B5819WS		1	mA
Forward voltage	V _F	B5817WS I _F =1A		0.45	V
		I _F =3A		0.75	
		B5818WS I _F =1A		0.55	V
		I _F =3A		0.875	
		B5819WS I _F =1A		0.6	V
		I _F =3A		0.9	
Diode capacitance	C _D	V _R =4V, f=1MHz		120	pF

TYPICAL CHARACTERISTICS @ $T_a=25$ unless otherwise specified

Fig. 1 - Forward Current Derating Curve

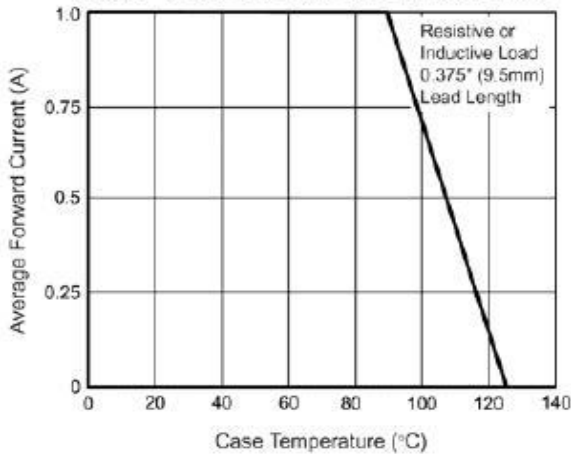

Fig. 2 - Maximum Non-Repetitive Peak Forward Surge Current

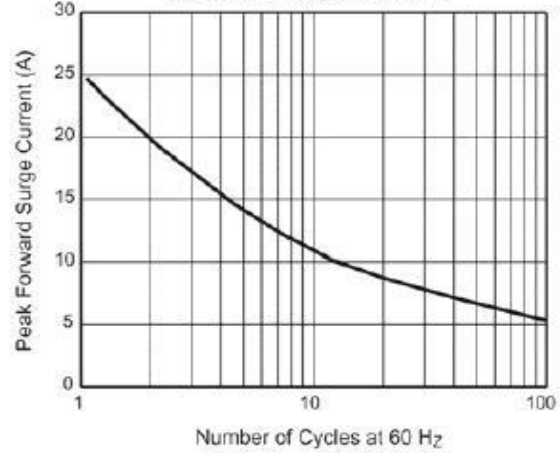

Fig. 3 - Typical Instantaneous Forward Characteristics

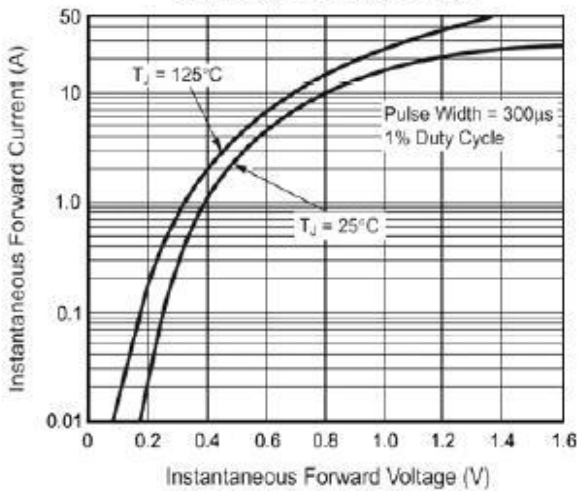

Fig. 4 - Typical Reverse Characteristics

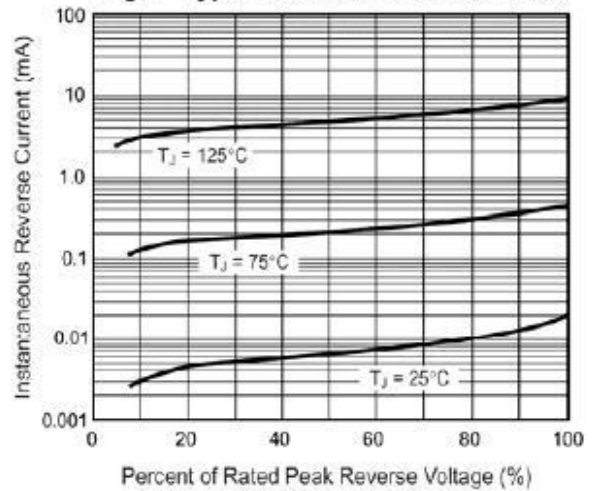

Fig. 5 - Typical Junction Capacitance

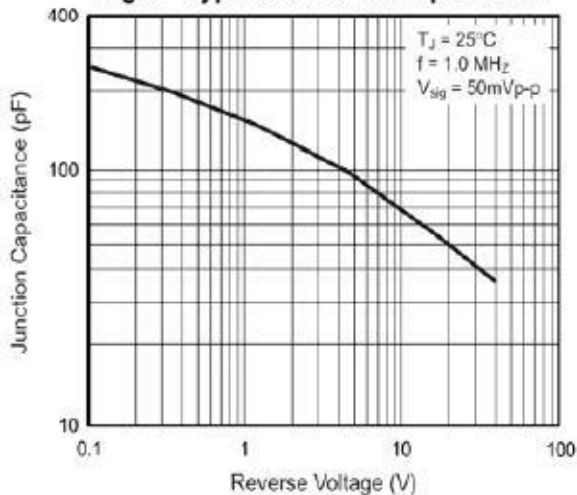
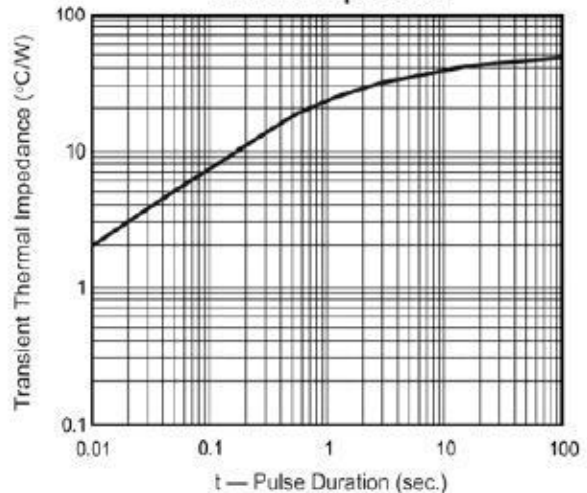
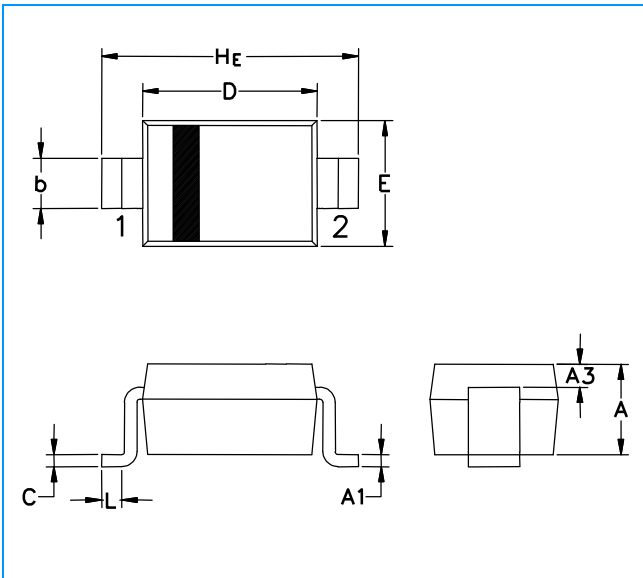

Fig. 6 - Typical Transient Thermal Impedance



SOD-323 Package Outline & Dimensions



Symbol	Millimeters			Inches		
	Min.	Nom.	Max.	Min.	Nom.	Max.
A	0.80	0.90	1.00	0.031	0.035	0.040
A1	0.00	0.05	0.10	0.000	0.002	0.004
A3	0.15 REF			0.006 REF		
b	0.25	0.32	0.40	0.010	0.012	0.016
C	0.089	0.12	0.177	0.003	0.005	0.007
D	1.60	1.70	1.80	0.062	0.066	0.070
E	1.15	1.25	1.35	0.045	0.049	0.053
L	0.08			0.003		
HE	2.30	2.50	2.70	0.090	0.098	0.105

Soldering Footprint

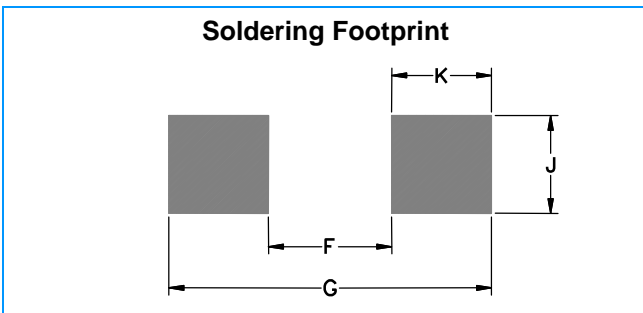

Symbol	Millimeters	Inches
F	1.60	0.063
G	2.85	0.112
J	0.83	0.033
K	0.63	0.025

PACKAGE INFORMATION

Device	Package	Shipping
B5817/18/19WS	SOD-323	3000/Tape&Reel